

SANUPS ASE-H

ASE10S1HU002-08

ASE10S1HU002-20

ASE10S1HU002-30

ASE10S1HU002-40

Uninterruptible Power Supply Unit

PDASEU02

UPS Power Distribution Unit

200V Type

Instruction Manual

SANYO DENKI

Introduction

Thank you for choosing the Model ASE10S1HU002-08,-20,-30,-40 and PDASEU02 UPS System.

SAVE THESE INSTRUCTIONS

This Manual contains important instructions for operating and maintaining the ASE10S1HU002 and PDASEU02 UPS System to protect the safety of the service technician and the customers. Read it carefully before operating or maintaining the UPS system, to ensure personal safety and proper device usage.

After reading, keep it in a place where it is easily accessible for reference.

This device is intended to be installed in a temperature-controlled indoor environment free of conductive contaminants.

- Operating temperature: 0 to 40°C (32 to 104°F)

UPS is an abbreviation for Uninterruptible Power Supply

Table of contents

1. Safety Precautions	1
2. Considerations for Proper Operation.....	5
◆ 2.1 Input Power Considerations	5
◆ 2.2 Installation Considerations	5
◆ 2.3 Usage Considerations	5
◆ 2.4 In Case of Trouble with the UPS.....	6
3. Confirming Package Contents.....	6
4. Overview	7
5. External Dimensions and Parts Names	9
◆ 5.1 UPS Unit.....	9
◆ 5.2 Control Panel/Indicators	10
◆ 5.3 UPS Power Distribution Unit.....	11
6. Carrying and Installation.....	12
◆ 6.1 Environment.....	12
◆ 6.2 Carrying	12
◆ 6.3 Installation	12
7. Unit Settings and Wiring	13
◆ 7.1 External Control Signals	13
8. Preparations Before Operation	15
9. Operation.....	16
◆ 9.1 Starting Operation (Normal Start)	16
◆ 9.2 Starting Operation (Battery Start)	18
◆ 9.3 Power Outage Simulation Test.....	20
◆ 9.4 Operation Shutdown (Daily).....	21
◆ 9.5 Operation Shutdown (If UPS is not to be used for a week or more).....	21

10. Operating and Protective Functions	22
◆ 10.1 Basic Operation	22
◆ 10.2 Protective Functions	24
◆ 10.3 Protective Function Chart	26
11. Maintenance and Inspection	27
◆ 11.1 Daily Inspection.....	27
◆ 11.2 Periodic Inspection	27
◆ 11.3 Periodic Parts Replacement.....	27
◆ 11.4 Battery Maintenance and Inspection.....	28
◆ 11.5 Fuse Replacement	28
12. Special Functions	29
◆ 12.1 Battery Test	29
◆ 12.2 User Settings	30
◆ 12.2.1 PC Interface Selection.....	32
◆ 12.2.2 Communications Baud Rate Selection	32
◆ 12.2.3 Power Outage Beeper Setting.....	33
◆ 12.2.4 Frequency Sync Range Selection.....	33
◆ 12.2.5 Autostart After Power Recovery Setting.....	33
◆ 12.2.6 INV ON/STAND BY Button Response Time Setting	34
◆ 12.2.7 Ring Signal Start Setting.....	34
◆ 12.2.8 Battery Starting Frequency Setting.....	34
13. Specifications.....	35
14. Warranty Conditions.....	36
Appendix	37
■ SANYO DENKI Co., Ltd. Head office, branch offices	

1. Safety Precautions

PRECAUTIONS (IMPORTANT SAFETY INSTRUCTIONS) SAVE THESE INSTRUCTIONS

Before installing, operating, performing maintenance or inspecting the UPS, be sure to read this manual and accompanying documents carefully to obtain a clear understanding of the information related to its operation, safety and important precautions.

This manual described two warning levels, DANGER and CAUTION, as described below.



Denotes immediate hazards which WILL probably cause severe bodily injury or death, as a result incorrect operation.



Denotes hazards which COULD cause bodily injury and product or property damage, as a result incorrect operation.

Additionally, even those hazards denoted by  could lead to a serious accident, so the instructions should be strictly followed.

The following labels indicate particularly important instructions which must be carefully followed. The graphic symbols indicate prohibited and mandatory actions.



Indicates actions that must not be allowed to occur (prohibited actions).



Indicates actions that must be taken (mandatory actions).

This example signifies that the equipment must be securely grounded.

1. Installation Precautions





- The UPS should be installed only by technically qualified personnel. Improper installation can result in electric shock, bodily injury, and/or fire.
- Never operate or store the UPS in the following environmental conditions. Doing so may cause the UPS to malfunction, sustain damage or deteriorate, which could result in a fire.
 - a. In ambient environmental conditions other than those specified in the product brochure and instruction manual (temperature 0 to 40°C(32 to 104°F), relative humidity 30 to 90%), such as in extremely high or low temperature and high humidity.
 - b. Where the UPS is exposed to direct sunlight.
 - c. Where the UPS is directly exposed to the heat from a heat source, such as a stove.
 - d. Where the UPS may be subject to vibration or physical shock.
 - e. Near a device that may emit sparks.
 - f. In the presence of dust, salt or corrosive or flammable gas.
 - g. Outdoors
- Do not allow the air intake or exhaust vents to be obstructed. Keep the front and back of the UPS at least 20 cm(7.88in) away from the wall. If the air intake or exhaust vent is blocked, the internal temperature of the UPS rises, which could cause battery deterioration resulting in a fire. During maintenance, the UPS requires at least 1 m (39.4in) space at the front and 50 cm(19.69in) at the back.
- The space around the UPS must be ventilated. Unless the specified ventilation airflow (5 m³/h) is maintained, gas produced by battery charging could result in rupture or explosion of the case.
- Install the UPS on a stable surface capable of bearing the weight of the UPS in the correct manner specified in this manual.
- If the UPS is installed incorrectly, impact or vibration could cause it to fall or move inadvertently, resulting in bodily injury. Be careful to avoid back strain.
- UL-Listed Branch circuit type overcurrent protection device rated min.250Vac, “2 Units Par.:15A, 3 Units Par.: 20A, 4 Units Par.: 30A, 5 Units Par.: 30A” must be provided for the input ac circuit by qualified personnel .
- UL-Listed Branch circuit type overcurrent protection device rated min.250Vac, “2 Units Par.:15A, 3 Units Par.: 20A, 4 Units Par.: 30A, 5 Units Par.: 30A” must be provided for protection of the output and input ac circuit by qualified personnel .

2. Wiring Precautions



- Wiring should be performed only by technically qualified personnel. Incorrect wiring can result in electric shock and/or fire.
- Wire with the specified wire and the specified torque surely.

Terminals	Minimum Wire Size				Temperature and Material	Torque
	No. of Parallel-Connected UPS Units					
Type	2 Units	3 Units	4 Units	5 Units		
Input/Output/Ground	14 AWG	12 AWG	12 AWG	10 AWG	Min. 75°C copper 3wire	1.5-1.8 N·m

- Connect the grounding cable securely in the manner specified. Failure to connect the grounding cable may result in electric shock. 
- The grounding cables of all load devices* connected to the output of the UPS must be securely connected to the grounding terminal. Failure to connect the grounding cables correctly may result in electric shock. 

* Load devices are devices such as computers that are connected to the UPS.

3. Operating Precautions



DANGER

- Immediately shut the UPS off if it malfunctions, or if an unusual odor or noise is observed. Failure to do so may result in a fire.
- To avoid electric shock, do not open the cover of the UPS.



CAUTION

- The space around the UPS must be well ventilated. Otherwise, gas produced by battery charging could result in rupture or explosion of the case.
- Before starting the UPS, make sure that the load side is safe. Be sure to refer to the instruction manual while operating the UPS. The operating state of the UPS, as determined by the ON/STAND BY switch, is indicated by the LEDs as shown the table below. Check these indicators when operating.
Be careful when operating the ON/STAND BY switch. If power is supplied incorrectly, an electric shock or bodily injury could result.

UPS status	LEDs
STAND BY	INPUT (on-green), OUTPUT (off-green)
ON	INPUT (on-green), OUTPUT (on-green)

- Avoid inserting sharp objects or fingers into the fan. Doing so may result in bodily injury.



PROHIBITED

- Never use the UPS for the following types of loads:
 - a. Medical instruments used for life support.
 - b. Control units for trains or elevators, failure of which could cause bodily injury.
 - c. Computer systems upon which social or public infrastructure depends.
 - d. Devices which serve applications related to the above.Contact your sales representative if you need to use the UPS in an application like the above. Special equipment, such as redundant devices or an emergency generator must be incorporated when operating, maintaining and controlling systems in which a UPS is used with loads affecting life-support or public infrastructure-dependent applications.
- Do not smoke or use an open flame near the UPS, as it could cause the UPS to explode or rupture, resulting in injury or fire.
- Do not place containers of liquid, such as a flower vase, on the UPS. If the container was to spill, the liquid could cause a short circuit, resulting in sparks or fire inside the UPS.
- Do not sit, step or lean on the UPS, as bodily injury could result if the UPS was to fall.

4. Maintenance and Inspection Precautions



CAUTION

- Maintenance and repair of the inside of the UPS should be performed only by technically qualified personnel. Electric shock, bodily injury and burns, fuming, or fire could otherwise result.
- Contact your nearest sales representative or authorized service center to have the UPS checked out or to replace defective parts. Opening the cover carelessly can result in an electric shock or burn.
- Replace the batteries periodically (once every 4.5 years when operated at 25°C(77°F)). Using batteries after their service life has expired may cause a fire.
- Do not allow sharp metallic objects or fingers to touch the battery connectors of the UPS. Doing so may result in an electric shock.
- Do not touch any parts inside the UPS, even when AC input is removed. Voltage produced from the batteries can still cause an electric shock.

5. Relocation and Transportation Precautions



CAUTION

- Be careful to avoid falling or dropping the UPS during relocation or transportation, as bodily injury could result.
- Be careful to avoid back strain when handling the UPS.
- To avoid bodily injury caused by dropping the UPS, do not tilt it more than specified degrees to either side when moving it. Take preventative measures to avoid dropping the UPS if it must be tilted more than specified degrees when moving it.

Equipment type name	No. of Parallel-Connected UPS Units			
	2 Units	3 Units	4 Units	5 Units
Angle of inclination (degree)	30	40	50	55

6. Battery Handling Precautions



CAUTION

- Battery servicing should be performed or supervised by technically qualified personnel knowledgeable about batteries and the required precautions. Keep unqualified personnel away from batteries.
- Nominal battery voltage is 36 volts DC.
- Replace batteries only with the same model and brand: HF7-12 manufactured by Shin-Kobe Electric Machinery Co., Ltd.
- Customers should not dispose of used batteries themselves. Contact your nearest sales representative, authorized service center or sales office to dispose of used batteries.
- Do not use batteries after their service life has expired. Doing so may result in fuming or fire. Additionally, the battery backup function may fail to operate with such batteries, so that power will not be supplied to the load when a power outage occurs.
- Batteries pose hazards for electrical shock and dangerous short-circuit current. The following precautions should be observed when working with batteries:
 - a. Remove watches, rings and other metal objects.
 - b. Use insulated tools.
 - c. Wear rubber gloves and boots.
 - d. Do not lay tools or metal parts on top of batteries.
 - e. Disconnect the charging source prior to connecting or disconnecting battery terminals.
 - f. Determine whether the batteries have been inadvertently grounded, and if so, remove the source of grounding. Contact with any part of a grounded battery can result in electric shock.
- Do not attempt to open or disassemble batteries. The electrolyte is harmful to the skin and eyes. The battery contains diluted sulfuric acid, which is extremely toxic. If a battery leaks, take appropriate measures to prevent any battery fluid contacting your skin or clothing. Diluted sulfuric acid may cause blindness if it gets into the eye, may burn skin upon contact. It is electrically conductive and corrosive. Observe the following procedures if electrolyte spills:
 - a. Wear full eye protection and protective clothing.
 - b. If sulfuric acid contacts the skin, wash it off immediately with water.
 - c. If sulfuric acid contacts the eyes, flush thoroughly and immediately with water, and seek medical attention.
 - d. Spilled sulfuric acid should be washed down with a suitable acid-neutralizing agent, such as a solution of approximately one pound (500 grams) bicarbonate of soda in one gallon (4 liters) of water. The bicarbonate of soda solution should be applied until evidence of reaction (foaming) has ceased. The resulting liquid should be flushed with water and the area dried.
- Lead acid batteries can present a risk of fire due to generation of hydrogen gas. The following procedures should always be followed:
 - a. DO NOT SMOKE when near batteries.
 - b. DO NOT allow flames or sparks near batteries.
 - c. Before working with batteries, discharge static electricity from the body by first touching a grounded metal surface before touching the batteries.
- Do not dispose of batteries in fire, as they could explode.
- If a fire occurs near a battery, do not use water to extinguish it. Use only a powder-distinguishing agent (ABC). Using water can cause the fire to spread.
- Strictly observe the following precautions when handling the batteries. Failure to do so may cause battery leakage, overheating or explosion.
 - a. Do not solder to any part of the battery directly.
 - b. Do not charge the battery with reversed positive (+) and negative (-) terminal polarity.
 - c. Do not mix different battery types, brands or versions.
 - d. Do not attempt to peel off or break the outer covering of a battery.
 - e. Do not subject batteries to strong physical shock, or throw them away.
 - f. Clean batteries with water-moistened cloth. Do not use organic compounds such as gasoline, thinner, benzene or detergent.
 - g. Electrical energy may remain in a battery even after its service life has expired. Do not allow sparks near used batteries, and protect them from short-circuiting.

2. Considerations for Proper Operation

◆ 2.1 Input Power Considerations

- (1) The UPS version should match the AC line voltage (208, 220, 230 or 240 VAC $\pm 15\%$, and 50 or 60 Hz $\pm 5\%$). Specific voltages and corresponding versions are as follows:
- (2) The current capability of the AC supply must meet the requirements of the UPS (0.9 kVA to 4.5kVA). However, the circuit breaker in the source distribution panel should be rated one grade higher than the load demand.
- (3) Install the breaker (2 Units Par.:15A, 3 Units Par.: 20A, 4 Units Par.: 30A, 5 Units Par.: 30A) for the distribution board of the UL authorization.

◆ 2.2 Installation Considerations

- (1) Carefully consider the leakage current when a leakage circuit breaker is installed at the input side. The leakage current of the UPS system is maximum 9 mA (5 UPS Units in parallel).
- (2) Keep the UPS at least one meter away from CRT displays. Other devices which may be sensitive to magnetic flux should be kept away from the UPS, as it emits a slight amount of magnetic flux.
- (3) The UPS utilizes a fan for forced-air cooling. Provide at least 20 cm(7.88in) clearance at the front and back of the UPS to permit free airflow at the air intake and exhaust vents. For maintenance purpose, a space of at least one meter (39.4in) in front and 50 cm (19.69in) in the back of the UPS is needed. See “§6.3 Installation Space” for details.
- (4) If the AC source has one side grounded, the N terminal (phase) of the UPS must be the grounded phase.
- (5) If possible, avoid grounding the output (load) side. If one side must be grounded, the V terminal (phase) should always be the grounded phase (to avoid short-circuiting power to ground).

◆ 2.3 Usage Considerations

- (1) Never short-circuit the output terminals, or connect a load which draws short-circuit current. Doing so causes protective functions or fuse opening to prevent output.
- (2) Unsuitable load devices
Do not connect laser printers, plain paper fax machines, copy machines or overhead projectors as load devices. Such devices typically include heating elements that draw high current. This may cause an overload that could prevent battery backup operation when an outage occurs, or damage the UPS.
- (3) Power supply environment
If the UPS is used in an environment subject to long and frequent power outages (more than once a week), the batteries may not receive sufficient charge, which could result in foreshortened battery life and premature battery failure.
- (4) If the UPS is not operated for 6 months or more, the battery may require charging before use. Operate the UPS with no load for at least 20 hours once every 6 months.
- (5) Insulation testing
Before testing indoor wiring insulation, shut down the UPS and disconnect the input and output cables. Conducting an insulation test with the UPS connected may damage electronic components such as the built-in arrester.
- (6) The UPS is designed to be installed horizontally. However, if it must be installed vertically, the left side should be the lower side (the indicators at the higher side), and mounting brackets should be installed if needed.
For rack mounting, an optional mounting bracket is required. Please contact your sales representative for details.

◆ 2.4 In Case of Trouble with the UPS

If one of the following trouble indications occurs, contact your nearest sales representative.

- (1) The ALARM indication lamp lights red (except when the UPS shuts down during a long power outage).
- (2) The INV ON/STAND BY, INPUT and OUTPUT indicators don't light green during normal operation.
- (3) When any other symptom suspected to be a sign of trouble is observed.

3. Confirming Package Contents

When opening the package, please confirm the proper contents and contact your nearest sales representative if you find any discrepancy.

The package cartons are UPS Power Distribution Unit 1 set and Uninterruptible Power Supply Unit (hereinafter referred to as UPS Unit) 2 to 5 set. (The set number of UPS Unit depends on the unit number of parallel connection.)

The contents of each package are as follows.

- | | |
|---|---------|
| (1) Package contents of UPS Power Distribution Unit (PDASE) | per set |
| (a) UPS Power Distribution Unit | 1 unit |
| (b) Accessories | |
| Instllation and Maintenance Manual | 1 copy |
| <i>Instruction Manual</i> (this booklet) | 1 copy |
| Setting Manual | 1 copy |
| PC Interface cable | 1 pcs |
| Input/Output cable | 5 pcs |
| Terminal cover A | 1 pcs |
| Terminal cover B (Set in terminal cover A) | 1 pcs |
| Cable cover (For UPS Unit) | 1 pcs |
| Cable cover (For UPS Power Distribution Unit) | 1 pcs |
| Screw for cable cover | 1 pcs |
| Leg for vertical installation | 4 pcs |
| Manual for leg | 1 copy |
| (2) Package contents of UPS Unit (ASE10S1H) | per set |
| (a) UPS Unit | 1 unit |
| (b) Accessories | |
| Unit Interface cable | 1 pcs |
| Coupling bracket | 1 pcs |
| Screw for coupling bracket | 2 pcs |
| Bypass Fuse 8A | 1 pcs |
| Cable cover | 1 pcs |
| Screw for cable cover | 1 pcs |
| Ground plate | 1 pcs |
| Leg for vertical installation | 4 pcs |
| Manual for leg | 1 copy |

4. Overview

This uninterruptible power supply is designed to provide reliable and stable AC power to critical equipment that requires continuous uninterrupted power.

This UPS system consists of 2 to 5 based 1kVA UPS Unit connected in parallel. According to this configuration, when customer system requires greater power capacity due to load expansion, this UPS system capacity can be easily expanded by installing the additional UPS Units in the range from 2 to 5 kVA.

Moreover, This system has a high reliability for uninterruptible power supplying to be able to configure a N+1 operation for the "1-4kVA" load.

The UPS Unit consists of rectifier, charger, inverter, battery and utility power transfer (bypass) circuits. In the event of failure of the AC source (utility power), inverter operation is sustained by converted DC power supplied from the batteries. When the utility power recovers, inverter operation continues while the battery is recharged. The UPS system is therefore able to supply completely uninterruptible AC power to connected loads without so much as a moment of power loss.

If a fault occurs in an inverter or the UPS output is overloaded, the output automatically switches the source of AC power to the bypass circuit, without interruption, the utility power is supplied to connected loads.

This UPS system consists of the basic 1 kVA UPS Unit including the batteries, up to 5 unit, and UPS Power Distribution Unit.

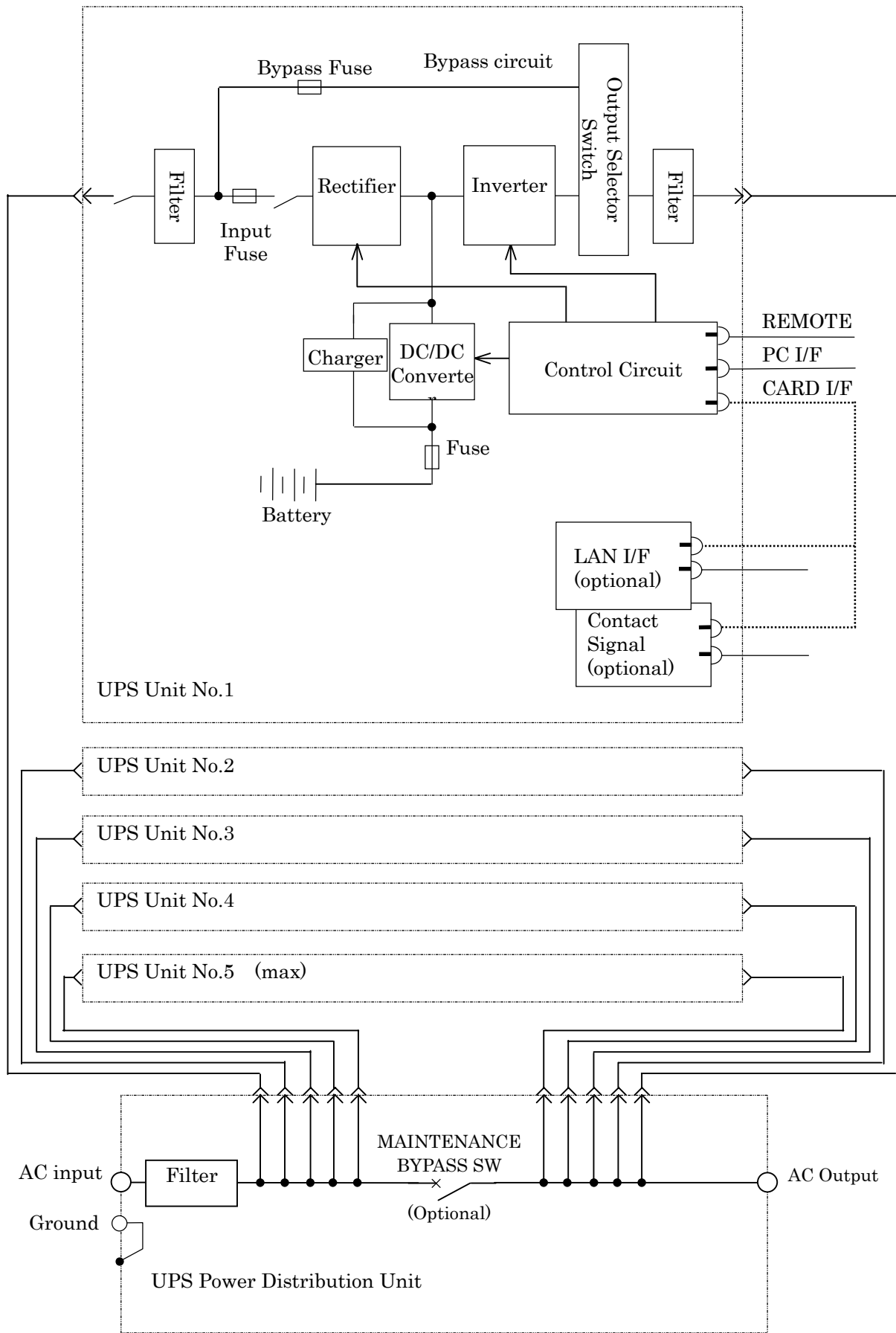

UPS system Block Diagram

5. External Dimensions and Parts Names

◆ 5.1 UPS Unit

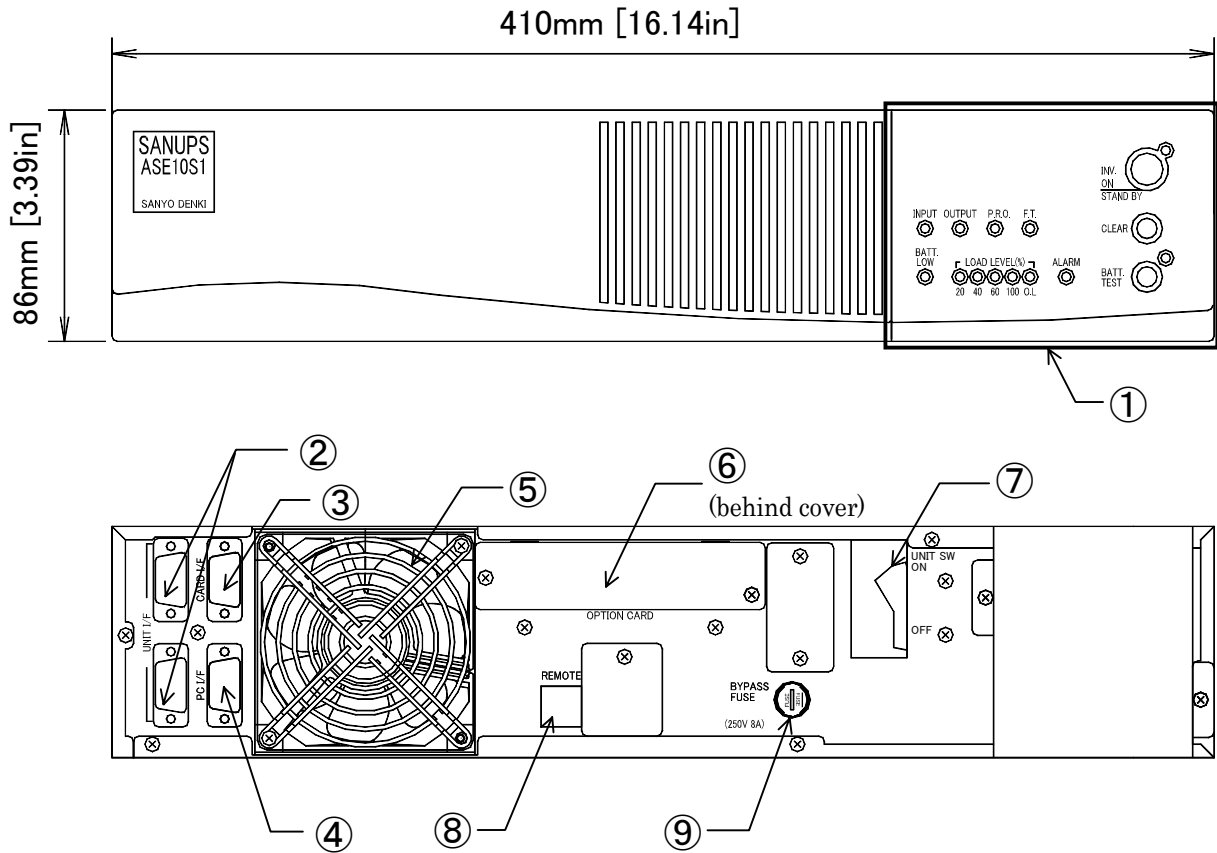

Depth: 435 mm (17.13 in)

Weight: 19 kg (41.89 lbs)

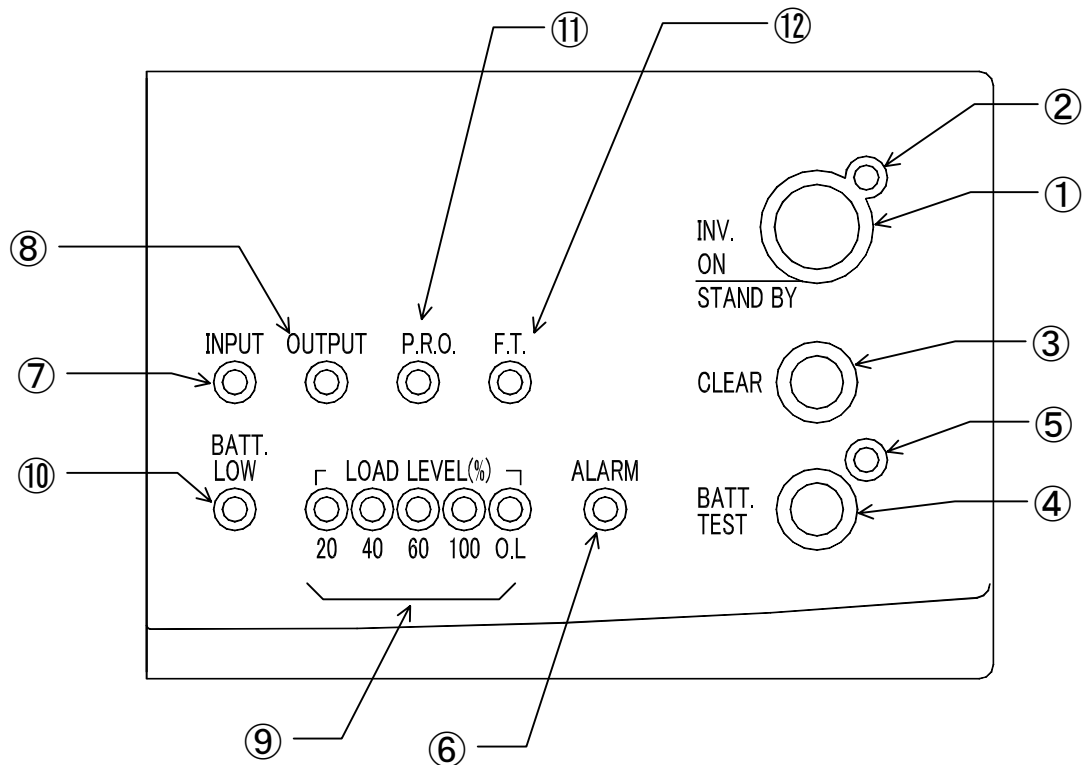

No.	Name	Marking	Function
①	Control Panel, Indicators	—	Operating controls and indicators
②	Unit Interface	UNIT I/F	For inter-unit connections with Unit Interface Cables
③	Card Interface	CARD I/F	For connecting external communications and card options
④	PC Interface	PC I/F	For PC or workstation communications
⑤	Cooling Fan	—	Cooling
⑥	Optional Card Slot	OPTION CARD	Compartment for installing optional card
⑦	Unit Switch	UNIT SW	Input power on/off for UPS Unit
⑧	Remote On/Off Connector	REMOTE	Connection terminal for remote On/Off switch
⑨	Bypass Fuse	BYPASS FUSE	Bypass circuit protection fuse

◆ 5.2 Control Panel/Indicators



No.	Name	Marking	Function
①	INV ON/STAND BY Switch	INV ON/STAND BY	Switches inverter operation on/off
②	INV ON/STAND BY Indicator	—	Lights (green) when power is supplied through the inverter, and blinks when supplied through the bypass circuit
③	Clear Switch	CLEAR	Silences the beeper and clears battery test results
④	Battery Test Switch	BATT.TEST	Starts and stops a battery test
⑤	Battery Test Indicator	—	Blinks during battery test Indicates battery test results: LED on = normal result, LED blinking = abnormal, LED off = stopped
⑥	Alarm Indicator	ALARM	Lights (red) if the UPS fails, and when the batteries are discharged below minimum operating voltage
⑦	Input Indicator	INPUT	Lights (green) when input utility power is normal, and blinks when input power is abnormal
⑧	Output Indicator	OUTPUT	Lights (green) when output power is supplied through the inverter, and blinks when supplied through the bypass circuit
⑨	Load Level Indicator	LOAD LEVEL	Indicates the load level (20, 40, 60, 100% or O.L. [Overload])
⑩	Battery-Low Indicator	BATT.LOW	Lights when battery voltage is low
⑪	Parallel Redundancy Operation Indicator	P.R.O.	Turns off when abnormal communications between units occurs, or if the No. of Units is incorrectly set
⑫	N+1 Redundancy Operation Indicator	F.T.	Lights during N+1 redundancy operation (lit when load level is below (N-1) kVA)

In this manual, switch names are denoted as (e.g.: INV ON/STAND BY).

The status of LEDs on the control panel are indicated as  for lit, and  for blinking.

◆ 5.3 UPS Power Distribution Unit

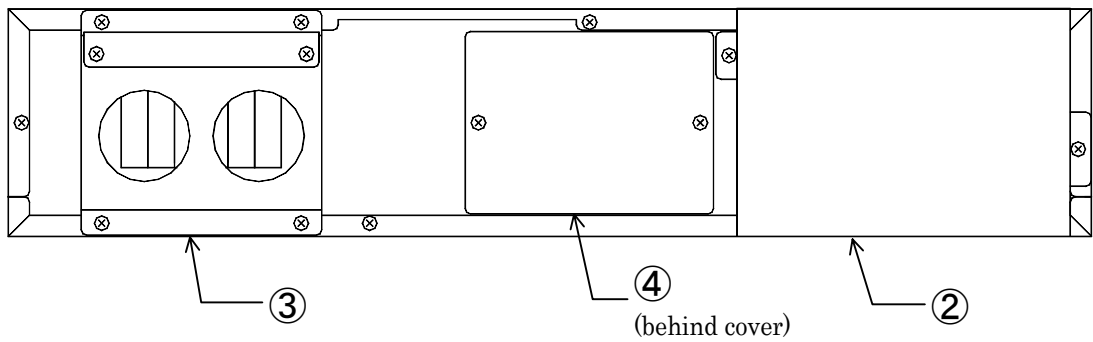
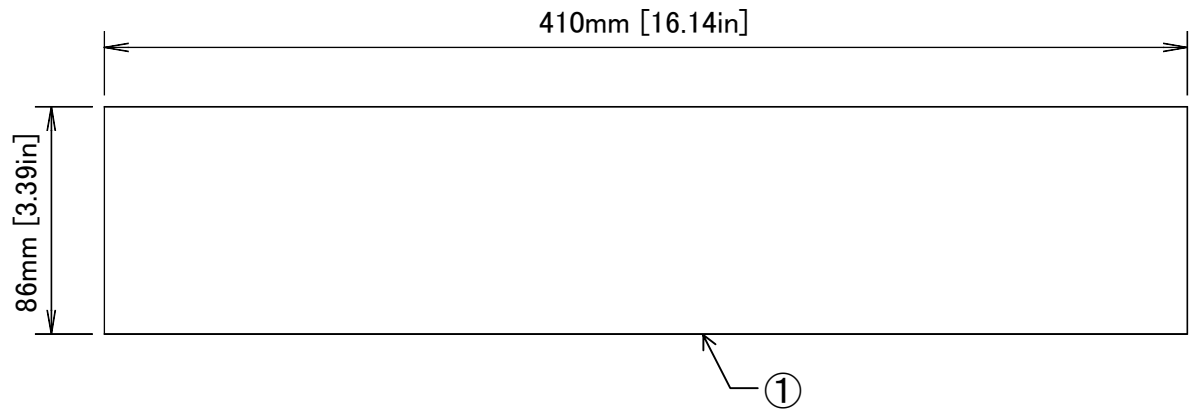

Depth: 410 mm (16.14 in)

Weight: 7 kg (15.43 lbs)

No.	Name	Marking	Function
①	Front Panel	—	—
②	Cable Cover	—	—
③	Terminal Brock Cover	—	—
④	Maintenance Bypass Switch (Optional)	MAINTENANCE BYPASS SW	Molded case cam switch for maintenance (normally OFF)

6. Carrying and Installation



Each UPS Unit weighs about 19 kg (41.89 lbs), and the UPS Power Distribution Unit weighs about 7 kg (15.43 lbs).

- Install the UPS on a stable surface that can bear the weight of all units.
- This surface should be flat, so the UPS cannot fall and cause bodily injury.
- The possibility of vibration and shock should be minimized at the installation location.
- Be careful to avoid lower back strain when carrying and installing.
- The UPS might fall or be dropped during relocation or installation. Always hold the UPS Units securely by the upper corners. Bodily injury could result if a UPS falls to the floor.

◆ 6.1 Environment

Do not install the UPS in the following locations:

- Where the ambient temperature exceeds 40°C (104°F).
For optimum battery life, install the UPS where ambient temperature stays between 20 and 25°C (68 and 77°F).
- Where high humidity may occur.
- Where corrosive gas or salt spray may be present.
- Where it may be subject to vibration and shock.
- Where dust may accumulate.

◆ 6.2 Carrying

Carry the UPS within its packing cartons, removing only when near the installation location.



- To avoid bodily injury from dropping a UPS Unit, do not tilt it more than specified degrees to either side when moving it. Take preventative measures to avoid dropping a UPS if it must be tilted more than specified degrees when moving it.

Equipment type name	No. of Parallel-Connected UPS Units			
	2 Units	3 Units	4 Units	5 Units
Angle of inclination (degree)	30	40	50	55



◆ 6.3 Installation

The UPS is designed to be installed either horizontally in a rack or vertically on the floor. When installed vertically, the left side (as viewed from the front) should always be the lower side (with the control panel at the upper side), and the coupling brackets should be installed. Provide the following space around the UPS system.

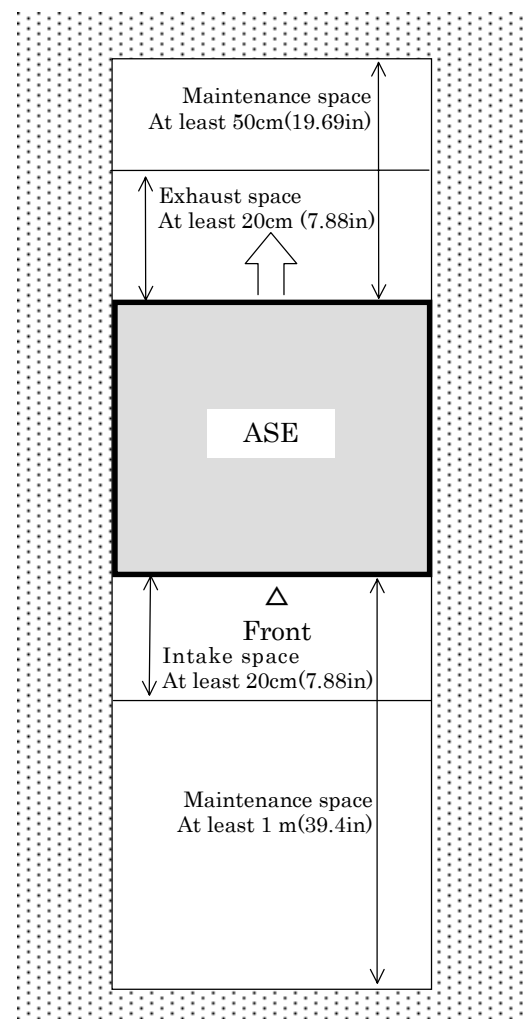
- At least 20 cm(7.88in) at the front as air intake space for the cooling fan.
- At least 20 cm (7.88in) at the back as air exhaust space for the cooling fan.
- At least 1 meter(39.4in) at the front and 50 (19.69in)/cm at the back for maintenance when needed
- At least 1 meter(39.4in) from CRT displays to allow for slight leakage of magnetic flux. Allow some space from devices which might be affected by magnetic flux.



7. Unit Settings and Wiring

 <p>CAUTION</p>	<ul style="list-style-type: none">•Obtain the assistance of technically qualified personnel for wiring. Incorrect wiring can result in electric shock, injury or fire.•Make sure the input and output terminals and external control plugs are firmly connected. A loose connection can cause smoke or fire.•Make sure the ground terminal is connected to earth ground.  <p>Otherwise, there is danger of electric shock.</p>
---	---

◆ 7.1 External Control Signals

(1) External Interface Connector (CARD I/F)

This connector is specially designed for use with Sanyo card options (network interface card and contact-interface card). If you wish to use this connector for other devices, please contact your nearest sales representative.

(2) PC/Workstation Interface Connector (PC I/F)

- ① This connector can be used to control power by external communications from a computer (such as a PC or workstation) using the optional SanGuard power control software. Use the communications cable supplied with the UPS Power Distribution Unit.

PC I/F Setting: W/S Mode (§12.2.1)

- ② Signals are supported by the UPS monitoring functions of network operating systems (such as Netware and Windows NT).

By connecting a computer (PC or workstation) with the communications cable supplied with the UPS Power Distribution Unit, automatic shutdown can be controlled by the UPS services in Windows NT.

PC I/F Setting: Stand-Alone Mode (§12.2.1)

Precautions for using UPS monitoring functions

In the UPS Configuration window of the operating system, the Remote UPS Shutdown setting should be set to Positive. Refer to the documentation for your network operating system for details.

If the operating system does not support UPS monitoring functions (such as Windows 95 and 98), do not use the communications cable supplied with the UPS Power Distribution Unit, as backup will not occur in the event of a power outage.

(3) Remote ON/OFF Connector

This connector can be used for optional remote ON/OFF switching control.

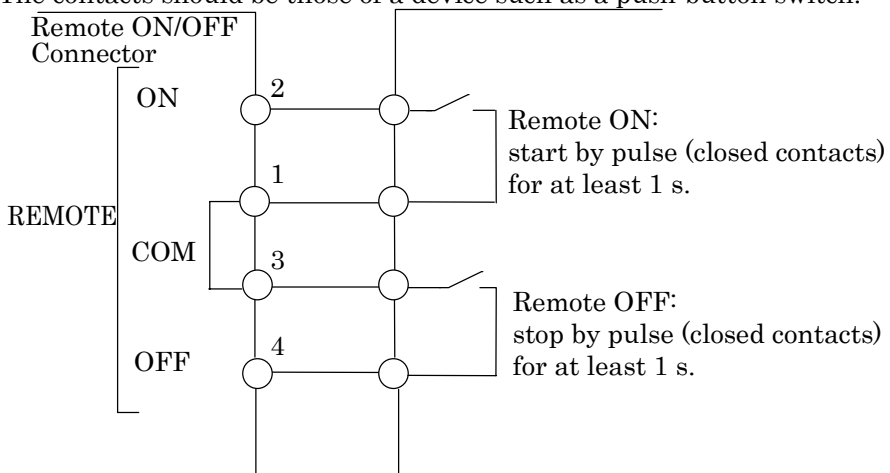
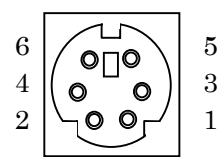
Signal Name	Description
<p style="writing-mode: vertical-rl; transform: rotate(180deg);">Signal Input</p> <p>Remote ON/OFF</p>	<p>The UPS can be remotely switched on and off by closed-circuit contact switching signals. The contacts should be those of a device such as a push-button switch.</p>  <p style="text-align: right;">Circuit Voltage: 5V DC Switching Current: about 12 mA</p> 

Operation is as follows according to the interface setting:

- Stand-Alone Mode: Remote ON/OFF
- Workstation Mode: Remote ON/One-Touch Shutdown

Precautions for using Remote ON/One-Touch Shutdown

In this case, an optional switch must be connected to the Remote ON/OFF connector of the unit that connects to the PC. If the Remote ON/OFF switch is connected to a unit that is not connected to the PC, One-Touch Shutdown is not available.

Note 1. The Stand-Alone and Workstation Modes are selected from the front panel. See §12.2.1, “PC Interface Selection” for details.

8. Preparations Before Operation

Check the following items before starting operation.

- ① Visually inspect the units to verify that there is no visible damage.
- ② Connect the UPS to a utility power source that meets the input specifications.
- ③ Verify that the **UNIT SW** on all UPS Units is turned OFF.

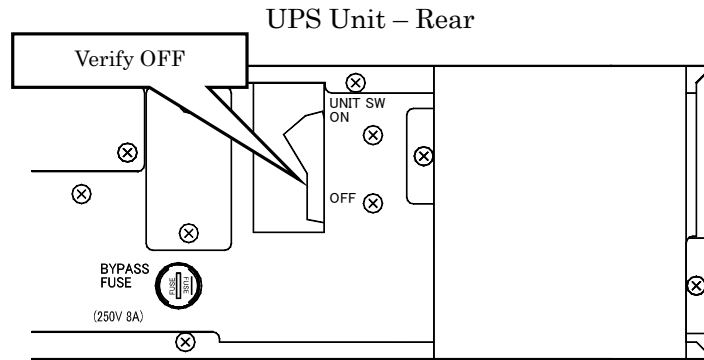

9. Operation

◆ 9.1 Starting Operation (Normal Start)

- ① Turn ON the distribution panel breaker of the AC source.
- ② Turn ON the **UNIT SW** on all UPS Units.

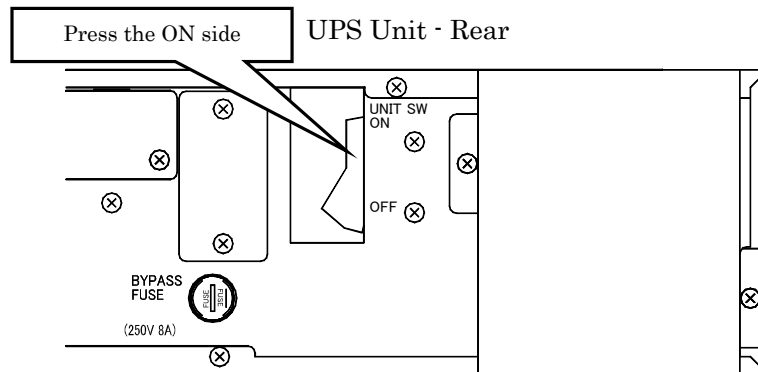

Caution



Always turn on the **UNIT SW** on all UPS Units. If a UPS Unit is not switched on, problems may occur as a result of inadequate power capacity.

UPS Unit - Front

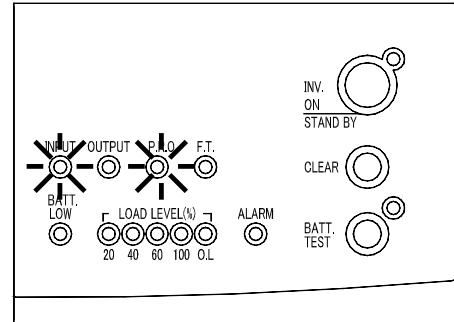
Device Status	LED
Cooling fan rotation, rectifier and charger starting, battery charge starting	INPUT (green) On P.R.O. (green) On



In this manual, switches are depicted as (e.g.: INV ON/STAND BY).

The status of LEDs on the control panel are indicated as  for lit, and  for blinking.

AT THIS TIME ...

If the LEDs do not light as above, the alarm sounds after a few seconds, indicating that settings or connections may have been made incorrectly. In that case, please contact your nearest sales representative.

- Press the INV ON/STAND BY switch of any UPS Unit for at least one second (which unit does not matter).

Beeper Sound : beep

Device Status	LED
Cooling fan rotation, rectifier and charger starting, battery charge starting	INPUT (green)On P.R.O. (green)On
After a second or two, the inverter starts	INPUT (green)On INV ON/STAND BY (green)On OUTPUT (green)On P.R.O. (green)On F.T. (green)On

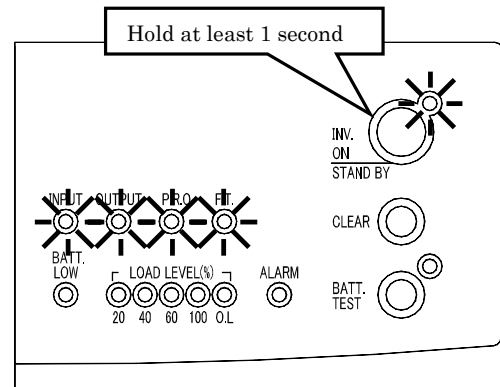

Note: The on/off state of the F.T. LED and LOAD LEVEL LED depends on the load level.

Caution

Do not press the INV ON/STAND BY switches of more than one UPS Unit at the same time.

Otherwise, problems such as abnormal startup may occur.

◆ 9.2 Starting Operation (Battery Start)

If the status of AC source is abnormal (such as an outage or low voltage), the UPS system provides AC power output from the batteries through the inverter.

- ① Verify that the **UNIT SW** on every UPS Unit is OFF.

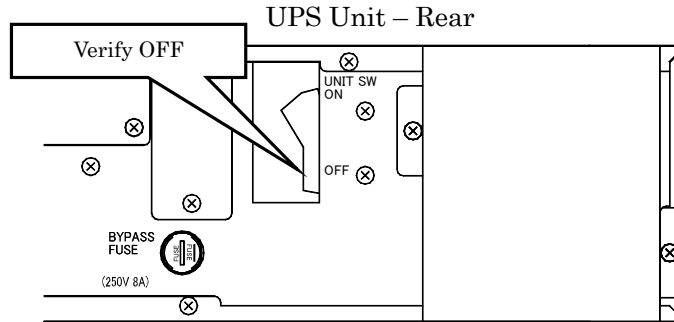

Device Status	LED
All stopped	All Off

UPS Front

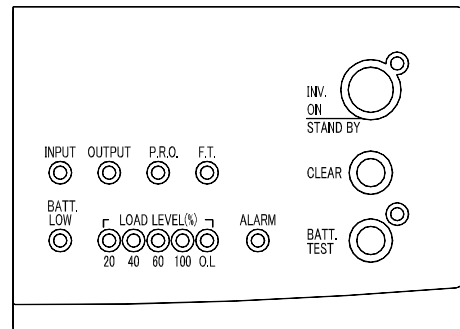

- ② Press **INV ON/STAND BY** on every UPS Unit for at least 6 seconds.

Beeper sound “Beep”
↓
Beep-beep...beep-beep...

Device Status	LED
Inverter operating from battery	INPUT (green) Blinking
	INV ON/STAND BY (green) On
	OUTPUT (green) On
	P.R.O. On
	F.T. On

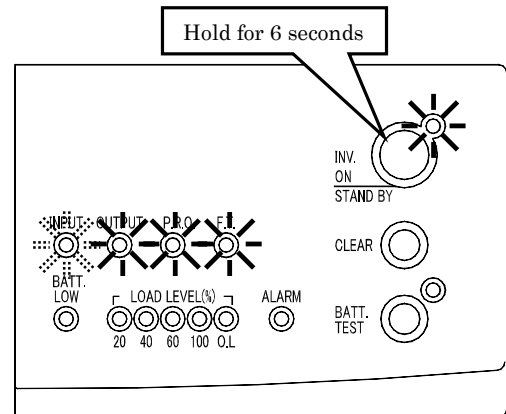

Note: The on/off state of the F.T. LED and LOAD LEVEL LED depends on the load level.

Note

The INPUT LED blinking and beeper sound timing may not always match for all UPS Units, but this does not indicate an abnormality.

Caution

When using this method to start the UPS system, connect and start the load only after all UPS Units have been started. The UPS system may not start correctly if started with a load already connected.

- ③ Turn on the **UNIT SW** on the rear of all UPS Units.

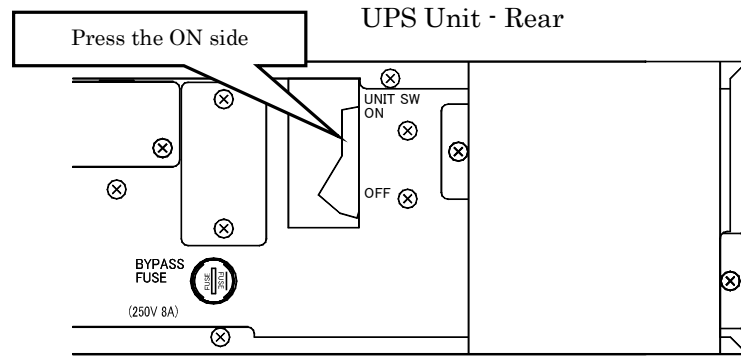

Caution

When the **UNIT SW** is not turned ON, even when utility power (AC input) returns to normal, the UPS cannot switch from the internal supply back to the utility power, so operation is the same as during an extended outage, and the batteries will be discharged. Be aware that, when restarting from this condition, the UPS system backup function will not be fully operational until the batteries have had time to recharge.

◆ 9.3 Power Outage Simulation Test

The power outage simulation test is performed to verify that the UPS system is functioning properly. This test is not needed when starting from the batteries (§9.2). The following indicates normal conditions.

Note
Perform this test before turning on connected loads.

- ① Turn OFF the distribution panel breaker of the AC source.

Beeper sound: Beep-beep...beep-beep...

Device Status	LED	
Inverter operating from battery,	INPUT (green)	Blinking
	INV ON/STAND BY (green)	On
Output supply continues	OUTPUT (green)	On
	P.R.O. (green)	On
	F.T. (green)	On

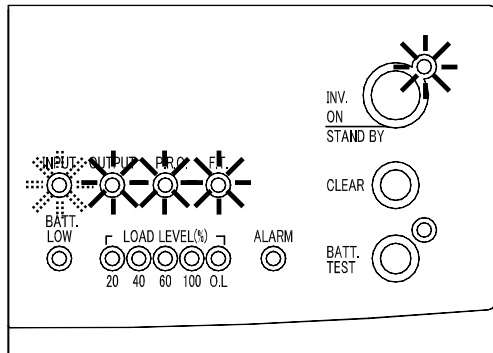

Note
The INPUT LED blinking and beeper sound timing may not always match for all UPS Units, but this does not indicate an abnormality.

- ② Turn the distribution panel breaker back ON.

Beeper sound: stops

Device Status	LED	
Rectifier, Charger start	INPUT (green)	On
Battery charging starts	INV ON/STAND BY (green)	On
	OUTPUT (green)	On
	P.R.O. (green)	On
	F.T. (green)	On

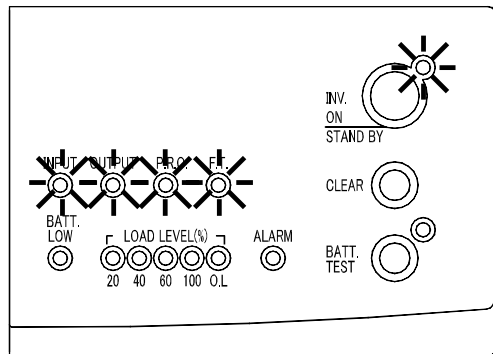

◆ 9.4 Operation Shutdown (Daily)

- ① Press and hold **INV ON/STAND BY** on any UPS Unit for at least one second.

Device Status	LED
Inverter stopped	INPUT (green) On
OUTPUT: stopped	INV ON/STAND BY (green)Off
Rectifier, charger operation continue	OUTPUT (green)Off P.R.O. (green)On F.T. (green)Off

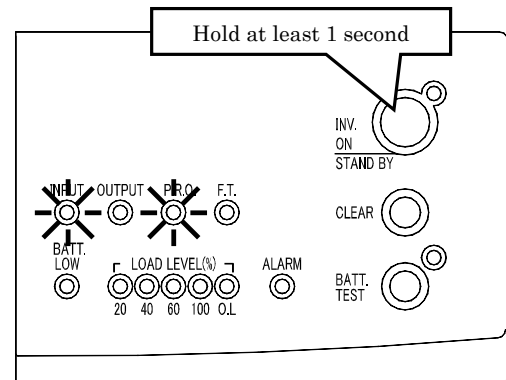

Caution

For daily shutdown, the **UNIT SW** should be kept ON (not used).

◆ 9.5 Operation Shutdown (If UPS is not to be used for a week or more)

- ① Press and hold **INV ON/STAND BY** on any UPS Unit for at least one second.
- ② Turn OFF the **UNIT SW** switches on all UPS Units.

Device Status	LED
Inverter stopped	INPUT (green) On
OUTPUT: stopped	INV ON/STAND BY (green)Off
Rectifier, charger operation continue	OUTPUT (green)Off P.R.O. (green)On F.T. (green)Off
↓ after about 10s	↓ after about 10s
All shut down	All turn off

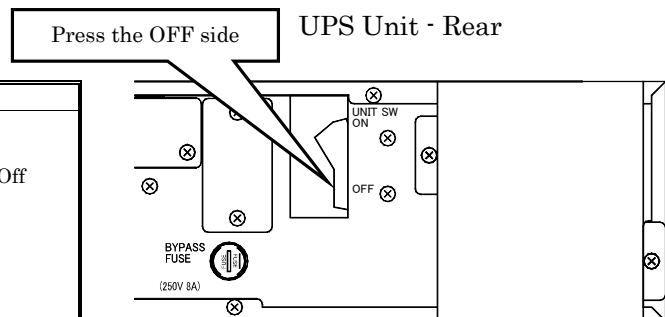

Note

If the input supply is removed while the UPS system is on, the batteries are discharged the same as during an extended outage. Be aware that when the input supply is restored, the full capacity of the backup function will not be available until the batteries have had time to recharge.

10. Operating and Protective Functions

◆ 10.1 Basic Operation

(1) Under normal conditions

Basically, the UPS converts AC power from the commercial source (AC input) into DC power through the rectifier, and reconverts this DC power back into AC power through the inverter. The reconverted AC power is synchronized with the commercial source to ensure a stable power supply to the loads. The batteries are kept continually charged and ready in case a problem (outage or voltage drop) occurs in the commercial power supply.

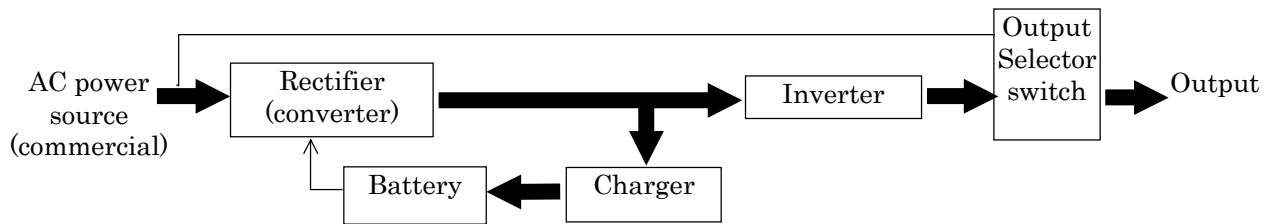

Power supply route in normal operation

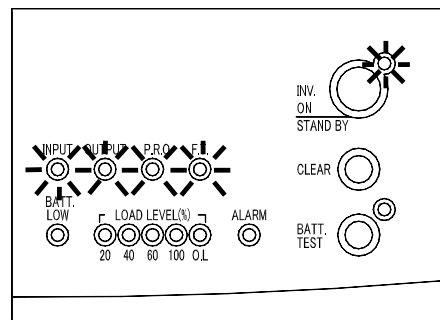

Note: The on/off state of the F.T. LED and LOAD LEVEL LED depends on the load level.

Indicator status (All UPS Units)

(2) Upon failure of commercial power

When a fault or an outage occurs in the commercial power source, the rectifier and charger cease operating while inverter operation continues, now using the batteries as a DC source, to ensure stable power supply to the loads without even a momentary power dropout. At this time, the battery operation beeper sounds and the green INPUT indicator lamp blinks. Pressing **CLEAR** silences the beeper.

Also, because each UPS Unit has its own **CLEAR** button, it must be pressed on every unit.

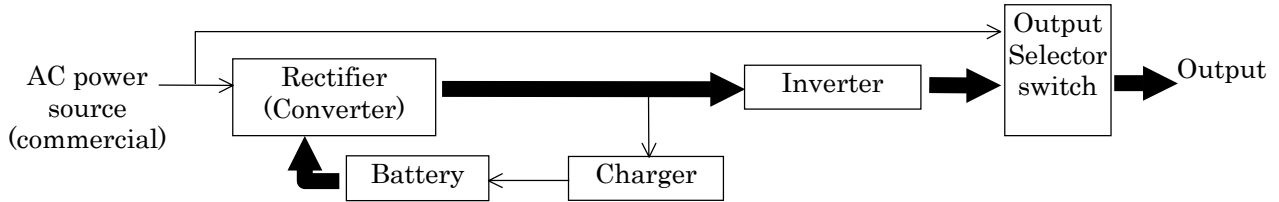

Power supply route upon failure of commercial power

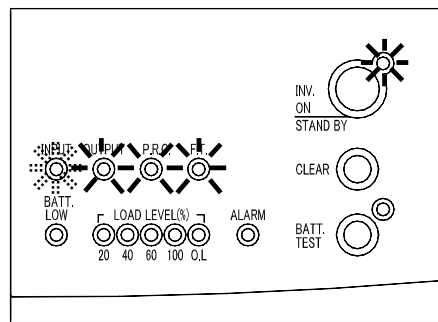

Note: The on/off state of the F.T. LED and LOAD LEVEL LED depends on the load level.

Indicator status upon failure of commercial power

(3) When battery voltage becomes low

If the commercial power abnormality or outage persists, the BATT.LOW (low battery voltage) indicator on the panel lights when battery voltage falls below 1.85 volts per cell.

(4) Upon recovery of commercial power

When normal commercial power recovers, rectifier and charger operations resume automatically, returning to the normal operating state described in (1).

(5) Extended power outage

If a power outage persists and the battery voltage reaches the final discharge level, a protective circuit shuts off the inverter to prevent overdischarging the batteries. When normal commercial power recovers after the inverter has been stopped automatically, operation is automatically resumed, returning to the normal operating state described in (1).

◆ 10.2 Protective Functions

(1) Overload Protection

If the UPS outputs are overloaded by exceeding the current capacity of the inverter, such as when a computer system boots up, the output selector switch automatically switches the source of AC power from the inverter to the bypass source without interruption. After a certain period of time has elapsed, the source of AC power is switched back to the inverter without interruption (auto return).

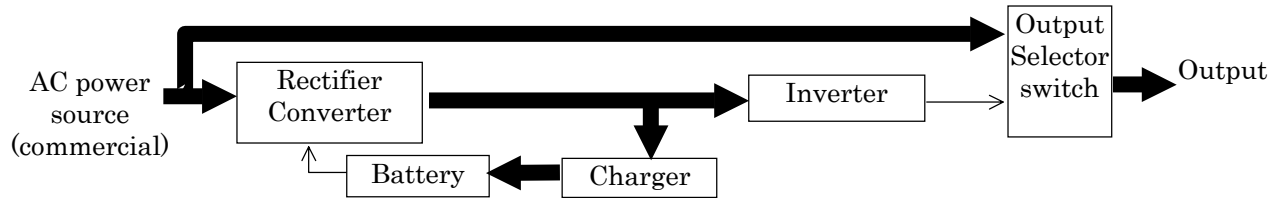

Power supply route in overload state

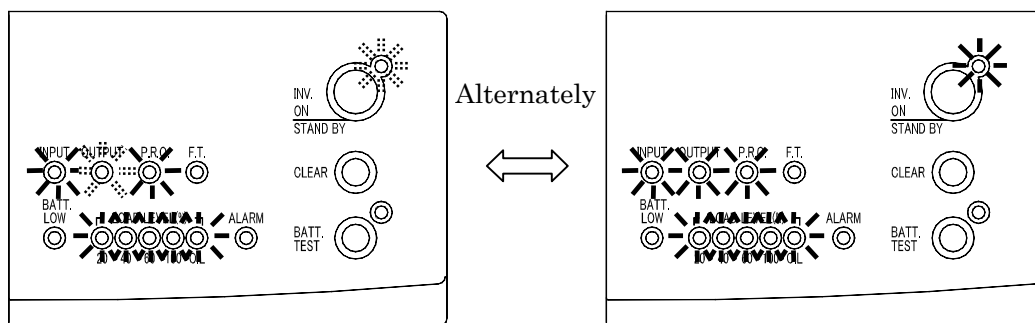

Bypass Supply Time

Inverter Supply Time

Indicator status during overload

(2) Inverter Failure

If a fault occurs in an inverter, the faulty unit is automatically isolated as inverter supply continues from the normal unit(s). The (red) ALARM indicator on the faulty unit lights, and its beeper sounds. Press **CLEAR** to silence the beeper.

At that time, operation is as follows, depending on the size of the load current.

Case 1. If the load current does not exceed the capacity of the remaining normal units, inverter supply continues.

Case 2. If the load current exceeds the capacity of the remaining normal units, operation alternates back and forth (auto-return) between inverter and bypass supply.

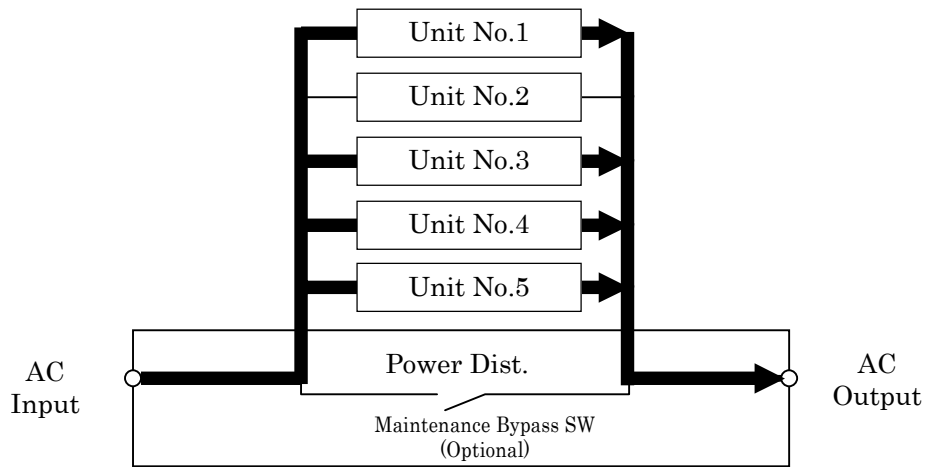

Power supply route when a UPS Unit fails (Here, Unit No. 2)

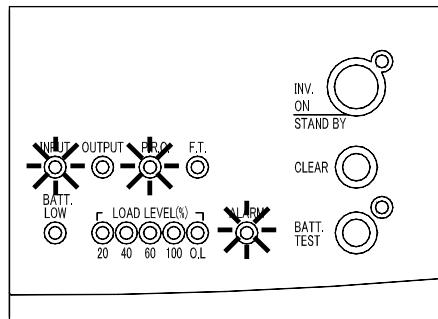

Indicator status when a UPS Unit has failed (faulty Unit)

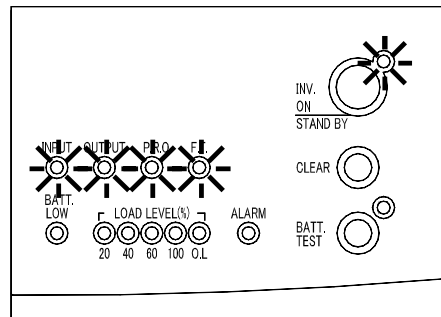

Indicator status when a UPS Unit has failed (normal Units): Case 1

For Case 2, operation is the same as the overload state

◆ 10.3 Protective Function Chart

The protective functions listed in this table protect the UPS system and connected devices.

○: Indicates a lamp lights, beeper sounds and an external signal is sent

Item	Control (front panel) indicators							Warning	External signal output: contact signal output (option)					Protective function (UPS operation)	Note		
	INPUT (green)	OUTPUT (green)	ALARM (red)	O.L (red)	BATT.LOW (red)	P.R.O. (green)	F.T. (green)	Beeper (Note 1)	AC input Abnormal	Battery Voltage low	AC output	Bypass Output	UPS abnormal				
00	Preparation	○	-	-	-	-	○	-	-	-	-	-	-	-	Rectifier, charger operation	Receiving AC power	
01	Normal	○	○	-	-	-	○	○ (*1)	-	-	-	○	-	-	Inverter operation	Receiving AC power, start	
02	Serious error	Failed UPS Unit	○	-	○	-	-	○	-	○ (1)	-	-	○	-	○	Failed UPS Unit is turned off Inverter power supply is continued	When a UPS Unit has failed
		Normal UPS Units	○	○	-	-	-	-	-	-	-	-	○	-	○		
		All UPS Units	○	○ (blink)	○	-	-	-	○	-	○ (1)	-	-	○	○	Inverter is turned off Bypass power supply	
03	Overload (Effective value)	○	○ (blink)	-	○	-	○	-	○ (4)	-	-	○	○	-	Bypass power supply	Auto return	
04	Forced bypass	○	○ (blink)	-	-	-	○	-	-	-	-	○	○	-	Bypass power supply	Manually switch to bypass AC power source	
05	Input overvoltage	○ (blink)	○	-	-	-	○	○ (*1)	○ (2)	○	-	○	-	-	Rectifier and charger turned off Inverter power supply is continued	Battery operation	
06	Input overvoltage (prolonged)	○ (blink)	○	-	-	○	○	○ (*1)	○ (3)	○	○	○	-	-	Rectifier and charger turned off Inverter power supply is continued	Battery operation Inverter turns off when battery discharged.	
07	Power outage	○ (blink)	○	-	-	-	○	○ (*1)	○ (2)	○	-	○	-	-	Rectifier and charger turned off Inverter power supply is continued	Battery operation	
08	Power outage (prolonged)	○ (blink)	○	-	-	○	○	○ (*1)	○ (3)	○	○	○	-	-	Rectifier and charger turned off Inverter power supply is continued	Battery operation Inverter turns off when battery discharged.	
09	Input abnormal (Frequency)	○ (blink)	○	-	-	-	○	○ (*1)	○ (2)	○	-	○	-	-	Rectifier and charger turned off Inverter power supply is continued	Battery operation	
10	Input abnormal (prolonged)	○ (blink)	○	-	-	○	○	○ (*1)	○ (3)	○	○	○	-	-	Rectifier and charger turned off	Battery operation Inverter turns off when battery discharged.	
11	P.R.O. malfunction	○	○	-	-	-	-	-	○ (5)	-	-	○	-	○	Inverter power supply is continued		

Note 1. Pressing **CLEAR** on UPS Unit front panel silences the beeper. If such trouble occurs, contact your nearest sales representative.

Beeper alarm sounds:

- (1) Beep ————— (continuous)
- (2) Beep beep ······ beep beep ······
- (3) Beep beep beep beep ······
- (4) Beep beep beep beep ······ Beep beep beep beep ···
- (5) Beep ·········· beep ··········

*1. Turns off when the load is [(overall system capacity) – 1 kVA] or more.

◆ 11.4 Battery Maintenance and Inspection

 CAUTION	<ul style="list-style-type: none"> • Battery replacement should be performed only by technically qualified personnel. Electric shock, injury, burning, smoke or fire could otherwise result. • Batteries should be replaced periodically. Batteries that have passed their service life may cause a fire. • Do not use organic solvents such as gasoline, thinner and benzene, or other cleaning compounds. These can adhere to seams in the battery casing, causing current leakage or fire.
---	--

(1) Battery Backup Confirmation

Battery backup capacity should be tested periodically (about once every 3 months), according to §12.1, “Battery Test”. As a result of battery test, if the battery replacement is required, please contact your nearest sales representative.

(2) Battery Replacement Period Prediction

Battery life is affected by operating conditions such as ambient temperature and number of discharges. Ambient temperature has a particularly strong influence as indicated in the following table (refer to the table to predict when batteries will need to be replaced according to ambient temperature). Using batteries after their life expectancy can cause leakage, and in the worst case damage may result, so we recommend changing batteries early as a preventative and protective step.

Ambient Operating Temperature	Life Expectancy	Battery Replacement Period
25°C (77°F)	5.0 years	4.5 years
30°C (86°F)	3.5 years	3.0 years
35°C (95°F)	2.5 years	2.0 years
40°C (104°F)	1.7 years	1.5 years

(3) Battery Specification

The batteries used in the UPS are specially designed for this application. Do not substitute with any other type, and do not mix brands or new and old batteries, as shortened battery life, fluid leakage and overheating could result.

(4) Used Battery Disposal

Batteries include poisonous lead substances, so to dispose of used batteries after replacement, please contact a waste disposal/recycling company, or return batteries to the place of purchase using the packaging in which the replacement batteries were supplied.

◆ 11.5 Fuse Replacement

 CAUTION	<ul style="list-style-type: none"> • Bypass fuse replacement should be performed only by technically qualified personnel. Electric shock, injury, burning, smoke or fire could otherwise result.
---	---

During bypass operation (OUTPUT LED blinking), if the red ALARM indicator is lit, a blown Bypass fuse may be suspected. In this case, please contact your nearest sales representative.

12. Special Functions

◆ 12.1 Battery Test

The battery backup time test checks whether the batteries are able to operate the existing load during a power outage. The test is performed without interrupting the load. We recommend that batteries be tested once every three months. The test should be performed after the batteries have been allowed to charge for at least 12 hours. However, if the P.R.O. LED is off, the battery test cannot be performed.

- ① On any UPS Unit (which one does not matter), press **BATT.TEST** for at least two seconds.

UPS status
Beeper sound: Beep beep···beep beep·· ·beep beep···
BATT.TEST (green) blinks
Battery operation for about two min.

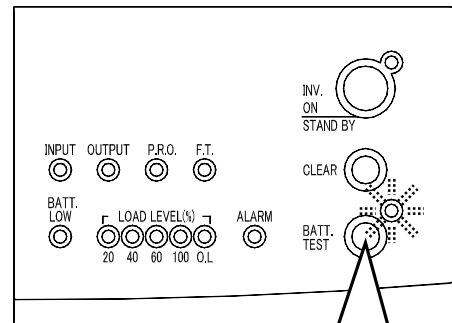

All of the green BATT. TEST LEDs blink, as testing of all batteries starts at once

Hold for at least 2 seconds.

The test finishes after about two minutes, then normal operation resumes with results indicated by the LEDs on each UPS Unit.

However, if an abnormal UPS Unit is found, testing of the other UPS Unit(s) is aborted.

Battery Test Results

Indication	Backup confirmation time	Judgment
Lit	more than 2 min.	Batteries are normal.
Long blinking	less than 2 min.	Replace batteries soon.
Off	—	Battery test aborted.

- ② If necessary, press **BATT.TEST** to abort the battery test.
Normal operation resumes.
- ③ When finished the test and after verifying battery test results, press **CLEAR** on all UPS Units.
The LEDs turn off.

The battery test aborts if one of the following conditions occurs:

- ① Abnormal AC input (voltage, frequency)
- ② Fault
- ③ Bypass switch change
- ④ Output overload
- ⑤ **INV ON/STAND BY** is OFF.
- ⑥ When any UPS Unit is abnormal

Note

This test provides only rough information. Even if the test results indicate normal battery condition, please contact your service representative when the battery expiration date is near.

◆ 12.2 User Settings

The user can make the following settings with the front panel controls:

- (1) PC Interface Selection (Stand-Alone or W/S Mode)
- (2) Communications Baud Rate Selection (9600, 4800 or 2400 bps)
- (3) Power Outage Beeper Setting (Beep/Silent)
- (4) Frequency Sync Range Setting (1, 3 or 5%)
- (5) Autostart after power recovery: Restart or Standby (Stop Output)
- (6) Response time of INV ON/STAND BY button
- (7) Ring Signal Start Setting (Enable/Disable)
- (8) Battery Starting Frequency (50/60 Hz)

All settings are performed using the following procedure.

Caution

Front panel settings affect only the UPS Unit on which they are made (the other UPS Units are not affected). However, the same settings should be made on all UPS Units.

- ① During inverter or standby operation, press **CLEAR** for at least 3 seconds.

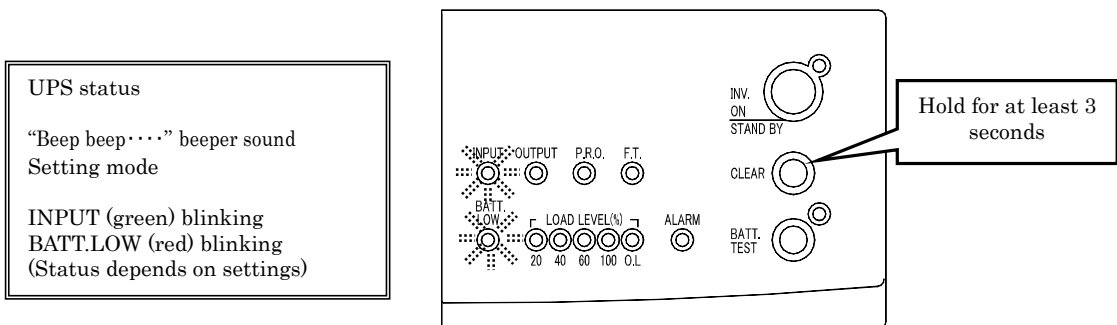

- ② The blinking pattern of the upper four LEDs now indicates the item to be set (§12.2.1 to §12.2.8), selected by pressing **CLEAR** briefly (less than 3 seconds). The blinking position changes each time you press **CLEAR**, so press it as necessary to select the item to set.

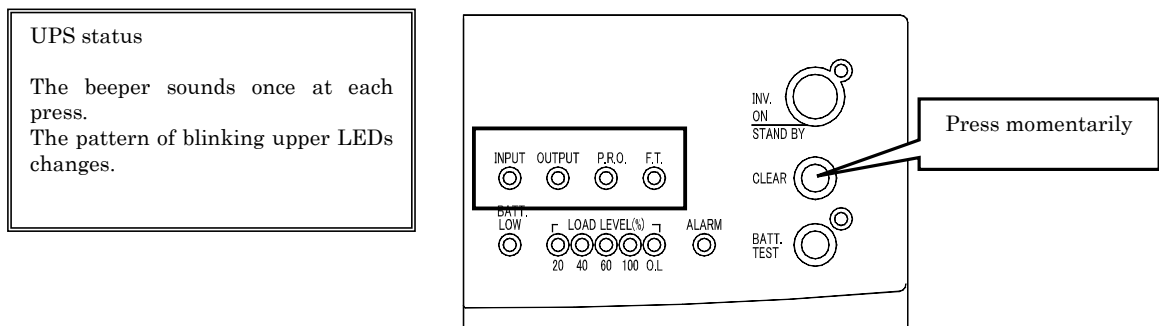

- ③ The blinking pattern of two of the lower LEDs indicates the current setting value (§12.2.1 to §12.2.8), selected by pressing **BATT.TEST**.

See the following pages for the specific indication corresponding to each setting value.

The blinking position changes each time you press **BATT.TEST**, so press it as necessary to select the desired setting value.

UPS status

The beeper sounds once at each press.
The pattern of blinking lower LEDs changes.

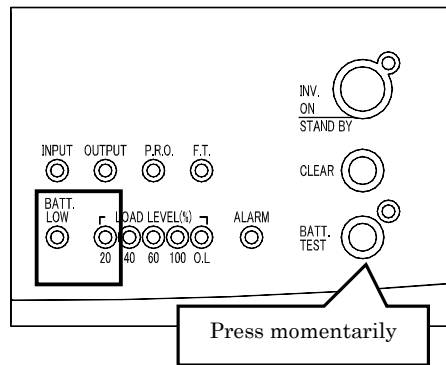

- ④ Press **CLEAR** for at least 3 seconds when finished making settings.
Two beeps sound, the setting status is memorized, and normal operation resumes.

Note

To reset all settings to their defaults (initial settings), press and hold **CLEAR** for more than 3 seconds after the beeper sounds in step 4 above.

◆ 12.2.1 PC Interface Selection

Selects the PC interface. Select the Stand-Alone mode to use the CARD I/F connector or a standard UPS service of a computer operating system, or select the W/S (Workstation) mode to use our optional power management software.

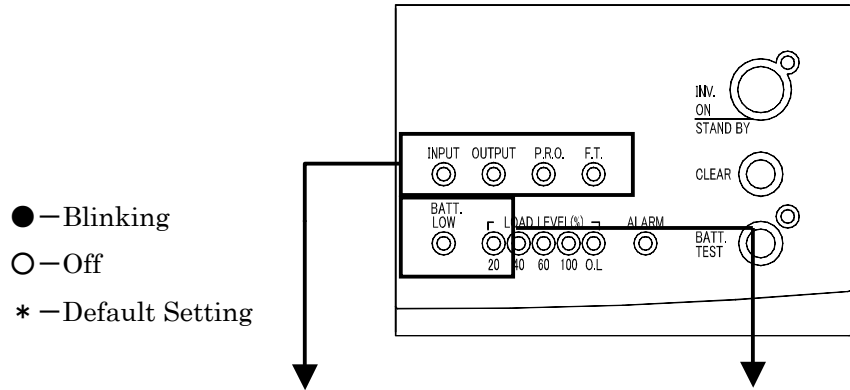

Setting item	Item LED indication	Setting value	Setting value LED indication
PC Interface setting	● ○ ○ ○	Stand-Alone*	● ○
		W/S	○ ●
		none	● ●

Caution

After changing the setting, turn off the **UNIT SW** on Stand By operation for at least one minute to shut down the inverter, and then restart (changes do not take effect until after restarting).

◆ 12.2.2 Communications Baud Rate Selection

Selects the communications baud rate for the PC interface.

Setting item	Item LED indication	Setting value	Setting value LED indication
Communications baud rate	○ ● ○ ○	9600*	● ○
		4800	○ ●
		2400	● ●

Caution

After changing the setting, turn off the **UNIT SW** on Stand By operation for at least one minute to shut down the inverter, and then restart (changes do not take effect until after restarting).

◆ 12.2.3 Power Outage Beeper Setting

Selects whether the beeper sounds during a power outage.

Setting item	Item LED indication	Setting value	Setting value LED indication
Power Outage beeper selection	● ● ○ ○	Beep*	● ○
		No beep	○ ●

◆ 12.2.4 Frequency Sync Range Selection

Set the range (%) of acceptable input frequency variation to be tracked by the output frequency. A smaller value provides better precision, but increases the likelihood of switching to battery power if the input frequency is unstable. Select a larger value if the UPS system is used with a device such as an EG (Engine Generator) that has wide frequency fluctuations.

Setting item	Item LED indication	Setting value	Setting value LED indication
Frequency tracking range	○ ○ ● ○	1%	● ○
		3%*	○ ●
		5%	● ●

Caution

After changing the setting, turn off the UNIT SW on Stand By operation for at least one minute to shut down the inverter, and then restart (changes do not take effect until after restarting).

◆ 12.2.5 Autostart After Power Recovery Setting

Set whether power output resumes automatically, or waits in standby with power output disabled, when power is restored after the UPS system has shut down during an outage under the following conditions:

- ① due to discharged batteries during backup operation
- ② while awaiting scheduled operation by the power management software
- ③ while awaiting the shut down function of the power management software.

Setting item	Item LED indication	Setting value	Setting value LED indication
Auto start after power outage	● ○ ● ○	Auto start*	● ○
		Stop Output	○ ●

◆ 12.2.6 INV ON/STAND BY Button Response Time Setting

Sets the response time of the INV ON/STAND BY button when the UPS Unit is set to the STANDBY state.

Setting item	Item LED indication	Setting value	Setting value LED indication
INV ON/STAND BY button response time	○ ● ● ○	1 second*	● ○
		3 seconds	○ ●

Caution

After changing the setting, turn off the **UNIT SW** on Stand By operation for at least one minute to shut down the inverter, and then restart (changes do not take effect until after restarting).

◆ 12.2.7 Ring Signal Start Setting

Sets Ring signal start capability. When a Ring signal is enabled, the PC can be started when the UPS system starts up.

Setting item	Item LED indication	Setting value	Setting value LED indication
Ring Signal Start	● ● ● ○	Enabled*	● ○
		Disabled	○ ●

Caution

This setting is effective only with PCs that support the Wake On Ring feature, and it must also be enabled in the settings on the PC.

After changing the setting, turn off the **UNIT SW** on Stand By operation for at least one minute to shut down the inverter, and then restart (changes do not take effect until after restarting).

◆ 12.2.8 Battery Starting Frequency Setting

Sets the AC output frequency when starting under battery power.

Setting item	Item LED indication	Setting value	Setting value LED indication
Battery starting frequency	○ ○ ○ ●	50 Hz*	● ○
		60 Hz	○ ●

Caution

After changing the setting, turn off the **UNIT SW** on Stand By operation for at least one minute to shut down the inverter, and then restart (changes do not take effect until after restarting).

13. Specifications

Item		Specifications/Characteristics				Remarks	
Output capacity		2 kVA / 1.4 kW	3 kVA / 2.1 kW	4 kVA / 2.8 kW	5 kVA / 3.5 kW	Apparent Power / Effective Power	
		1 kVA / 0.7 kW	2 kVA / 1.4 kW	3 kVA / 2.1 kW	4 kVA / 2.8 kW	Apparent Power / Effective Power (using N+1 configuration)	
Cooling system		Forced-air cooling					
AC input	Number of phases/wires	Single-phase 2-wire					
	Voltage	208, 220, 230, 240 V within $\pm 15\%$				Switch selectable (same as output voltage)	
	Frequency	50 or 60 Hz $\pm 1, \pm 3, \pm 5\%$				Tolerance is determined by output frequency accuracy setting (Note 1)	
	Power consumption	1.8 kVA	2.8 kVA	3.6 kVA	4.5 kVA	Maximum consumption during battery recovery charging	
	Input power factor	0.95 or more				At rated output (Note 2)	
AC output	Number of phases	Single phase 2-wire					
	Voltage	208, 220, 230, 240 V				Switch selectable	
	Voltage setting accuracy	Within $\pm 5\%$				At rated load	
	Frequency	50 or 60 Hz				Same as input frequency (automatic selection) (Note 3)	
	Frequency accuracy	Rated frequency within $\pm 3.0\%$ (when synchronized with commercial mains frequency)				1, 3, 5% (switch selectable) Internal oscillator accuracy $\pm 0.5\%$	
	Voltage waveform	Sine wave					
	Voltage waveform distortion	Linear load: 3% or less 100% rectifier load: within 8% or less				At rated output	
	Transient voltage tolerance	Rapid load change	$\pm 10\%$				0 \leftrightarrow 100% change or output change
		Power outage/recovery	$\pm 10\%$				At rated load
		Rapid voltage change on input	$\pm 10\%$				$\pm 10\%$ change
	Response time	5 cycles or less					
	Load power factor	0.7 (lag)				Variation range 0.7 (lag) to 1.0	
	Overcurrent protection function	Automatically switched to bypass circuit when more than 105%				Auto return function is provided	
Overload handling capacity	Inverter	105% or more				For 0.2 seconds	
	Bypass	200%				For 30 seconds	
		800%				For 2 cycles	
Battery	Type	Small sealed lead-acid storage batteries					
	Rated capacity	7 Ah				20-hour rate	
	Number of batteries	3 batteries (12V per battery)				Per UPS Unit	
	Back-up time	700W for 5 minutes, 500W for 10 minutes				Ambient 25°C(77°F), at rated load	
Ambient conditions	Ambient temperature: 0 to 40°C(32 to 104°F) Relative humidity: 30 to 90%				(Note 4)		
Audible noise	40 dB or less	45 dB or less			1 m from the UPS front panel		

Note 1. When AC input frequency is within $\pm 3\%$ (settable to $\pm 1, 3$ or 5%) of the rated frequency, and the AC input voltage is within $\pm 15\%$ of the rated voltage, inverter output is synchronized with the AC input. This makes possible switching of the power source without interruption. If the AC input frequency is outside of this range, battery operation is started.

Note 2. When voltage waveform distortion is less than 1%.

Note 3. When the basic frequency is changed (50 \leftrightarrow 60 Hz), battery operation starts at once while the system synchronizes with the new frequency, then normal operation resumes. Also, if the basic frequency is changed during a power outage, the new frequency becomes effective after power is restored.

Note 4. Because the UPS includes batteries, do not operate it for long periods where the ambient temperature exceeds 30°C(86°F).

Note 5. If grounded, the ground phase of the input and output must match according to UPS specifications.

14. Warranty Conditions

The warranty period for this UPS is one full year after purchase. After one year, repair service is available at a charge, subject to the following conditions.

Free Warranty Conditions

1. If the product malfunctions under normal operating conditions as stated in this manual, repair is provided free of charge during the warranty period.
2. If the UPS breaks down, please contact your nearest sales representative.
3. The warranty coverage does not include the following conditions.
 - (1) Defects or damages arising from improper repair, modification or wiring made by the customer.
 - (2) Defects or damages arising from fire, earthquake, rain or water disaster, lightning or other natural disasters including pollution, salt disaster, gas disaster (chloride gas), unusual voltage or incorrect power sources other than those specified.
 - (3) Defects or damages arising from improper handling, such as falling of the UPS during transportation or relocation by the customer after it has been delivered.

Other Precautions

1. Operation when an Alarm Event Occurs

- Do not immediately press the **INV.ON/STAND BY** button when an alarm event occurs, as this could interrupt power to the load.

On the UPS Unit where the alarm event occurred, turn the **UNIT SW** OFF, and verify that all front panel LEDs are off before pressing the **INV.ON/STAND BY** button (at this time, the load should be in a state that will not result in a problem if the power is cut). UPS system output is shut off normally by this procedure. Afterwards, the **UNIT SW** on any other UPS Units can be turned OFF to completely shut down the UPS system.

- If the **INV.ON/STAND BY** button is pressed by mistake after an alarm event occurs, the UPS system does not shut down, but switches to the bypass circuit to continue supplying the load. However, from this state, it cannot switch back to the inverter output. In this case, turn the **UNIT SW** on each UPS Unit OFF to shut down the UPS system completely, then restart it.

2. Alarm at Startup

- If an alarm occurs when starting, before pressing the **INV.ON/STAND BY** switch, commercial power may be supplied through the bypass circuit. Do not attempt to change any wiring at the output side while the **UNIT SW** is ON.

3. Minor Faults in SANGUARD IV Lite

- If an increase in the load causes transition from N+1 to N operation, the F.T. LED turns OFF at the UPS system side, while “Minor Fault” is displayed in SANGUARD IV Lite. Be aware that this is not an actual fault.

4. Displaying Battery Test Results in SANGUARD IV Lite

- When battery test results are normal, “Normal” is displayed in SANGUARD IV Lite. Otherwise, “Undetermined” is displayed, which indicates either a battery abnormality or interruption of the test.

Front Panel Setting Checklist

For your convenience, use this checklist to record changes to settings, by placing checkmarks in the appropriate boxes.

Setting Item	LED Item Indication	Setting Value	LED Setting Indication
PC I/F Setting	●○○○	<input type="checkbox"/> Stand-Alone	●○
		<input type="checkbox"/> W/S	○●
		<input type="checkbox"/> None	●●
Communications Baud Rate	○●○○	<input type="checkbox"/> 9600	●○
		<input type="checkbox"/> 4800	○●
		<input type="checkbox"/> 2400	●●
Power Outage Beeper Selection	●●○○	<input type="checkbox"/> Beep	●○
		<input type="checkbox"/> No beep	○●
Frequency Tracking Range	○○●○	<input type="checkbox"/> 1%	●○
		<input type="checkbox"/> 3%	○●
		<input type="checkbox"/> 5%	●●
Auto Start After Power Recovery	●○●○	<input type="checkbox"/> Auto Start	●○
		<input type="checkbox"/> Stop Output	○●
INV ON/STAND BY Button Response Time	○●●○	<input type="checkbox"/> 1 Second	●○
		<input type="checkbox"/> 3 Seconds	○●
Ring Signal Start	●●●○	<input type="checkbox"/> Enabled	●○
		<input type="checkbox"/> Disabled	○●
Battery starting frequency	○○○●	<input type="checkbox"/> 50 Hz	●○
		<input type="checkbox"/> 60 Hz	○●